

Sharkoon

# SHARK BLADES RGB FAN

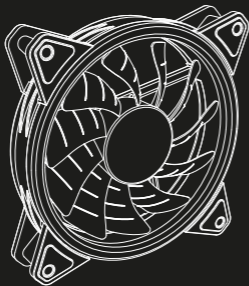

Manual • Anleitung • Manuel • Manuale dell'utente • Handleiding  
Instrukcja • Használati útmutató • Руководство пользователя  
Manuál • 使用説明 • マニュアル

# Specifications

## General:

■ Fan Speed	1,200 rpm $\pm$ 10%
■ Bearing Type	Fluid Dynamic Bearing
■ Max. Airflow	94.8 m <sup>3</sup> /h
■ Max. Air Pressure	1.16 mm H2O
■ Max. Noise Level	18.2 dBA
■ MTBF	Min. 50,000 Hours
■ Illumination	20x Addressable RGB LEDs
■ Dimensions (L x W x H)	120 x 120 x 25.5 mm
■ Weight incl. Fixed Cable	140 g

## Cables and Connectors:

■ Fan Connector	3-Pin
■ LED Connector	3-Pin & 4-Pin
■ LED Pinout	5V-D-G / 5V-D-coded-G
■ Fan Cable Length	450 mm Fan
■ LED Cable Length	500 + 50 mm

## Electrical Specifications:

■ Rated Voltage	12 V
■ Rated Current Fan	0.15 A
■ Rated Current LED	0.13 A
■ Rated Power Fan	1.8 W
■ Rated Power LED	1.56 W
■ Start Voltage	6 V



# Connect Fan

- Lüfter anschließen
- Connecter le ventilateur
- Collegamento ventole
- Conexión de ventilador
- Conectar ventoinha
- Verbind Ventilator
- Podłączenie wentylatora
- Csatlakoztassa ventilátort
- Připojte ventilátor
- Подключение вентилятора
- 風扇接頭
- ファンの接続

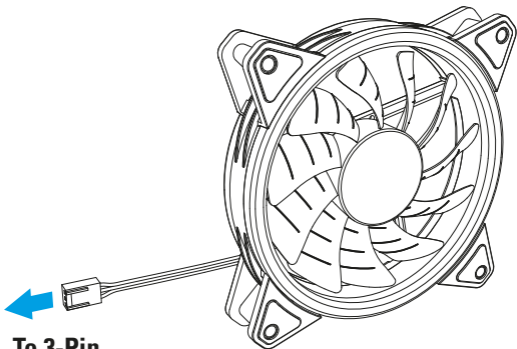

**To 3-Pin  
fan connector**

# Connect LED

- LED anschließen
- Connector la LED
- Collegamento LED
- Conexión de LED
- Conectar LED
- Verbind LED
- Podłączenie LED
- Csatlakoztassa LED
- Připojte LED
- Подключение LED-элементов
- LED 接頭
- LED の接続

## Mainboard Addressable RGB Pin Header

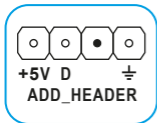
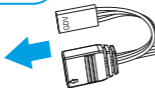
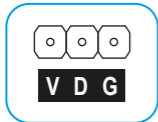

## Mainboard Addressable RGB Pin Header

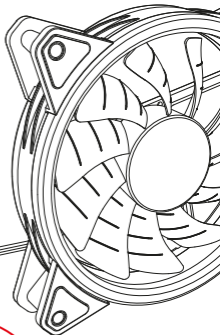
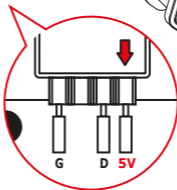

## Legal Disclaimer

For potential loss of data, especially due to inappropriate handling, SHARKOON assumes no liability.

All named products and descriptions are trademarks and/or registered trademarks of the respective manufacturers and are accepted as protected. As a continuing policy of product improvement at SHARKOON, the design and specifications are subject to change without prior notice. National product specifications may vary.

All rights reserved especially (also in extracts) for translation, reprinting, reproduction by copying or other technical means. Infringements will lead to compensation. All rights reserved especially in case of assignation of patent or utility patent. Means of delivery and technical modifications reserved.

## Disposal of your old products

Your product is designed and manufactured with high quality materials and components, which can be recycled and reused.



When this crossed-out wheeled bin symbol is attached to a product, it means the product is covered by the European Directive 2012/19/EU. Please be informed about the local separate collection system for electrical and electronic products. Please act according to your local rules and do not dispose of your old products with your normal household waste. The correct disposal of your old product will help prevent potential negative consequences to the environment and human health.

**SHARKOON Technologies GmbH**

Siemensstraße 38 | 35440 Linden | Germany

© **SHARKOON Technologies 2019**

info@sharkoon.com | www.sharkoon.com